

Intel GPU Driver

Константин Белоусов
kib@freebsd.org

24 сентября 2011 г.



Revision : 1.7

- Intel: Документация, драйвер для Linux
- AMD: Документация, бинарный драйвер для Linux
- Nvidia: Бинарный драйвер для Linux, FreeBSD, Solaris

- Intel: Документация, драйвер для Linux
- AMD: Документация, бинарный драйвер для Linux
- Nvidia: Бинарный драйвер для Linux, FreeBSD, Solaris

Intel documentation

GPU PRM

<http://intellinuxgraphics.org/documentation.html>

Chipset datasheets

- Gen0: i740
- Gen1: i810
- Gen2: i865g
- Gen3: i915g, i945g, G33, Pineview (Atoms)
- Gen4: i965g, G(M)45
- Gen5: Core i5 600
- Gen6: Sandybridge (Core i3/i5/i7 2XXX)
- Gen7: Ivybridge

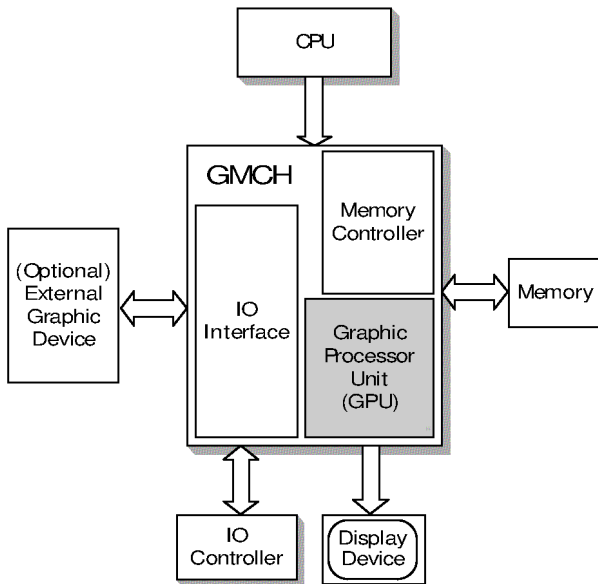

GPE - block diagram

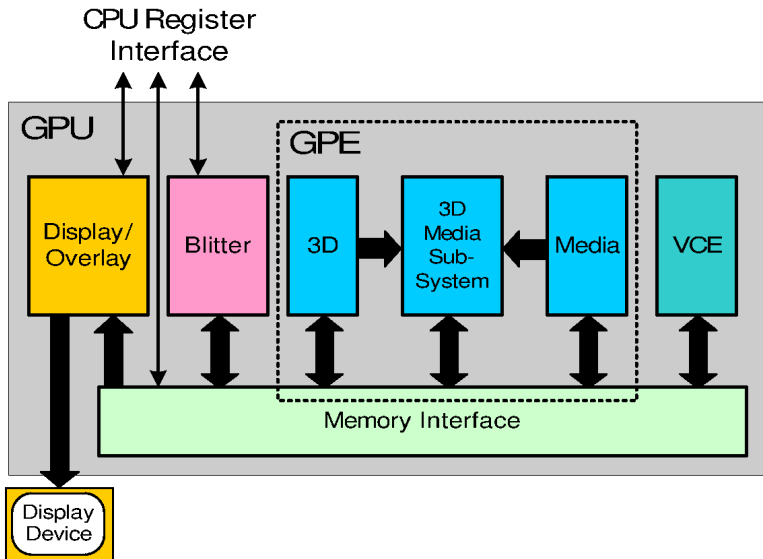

GPE - functional diagram

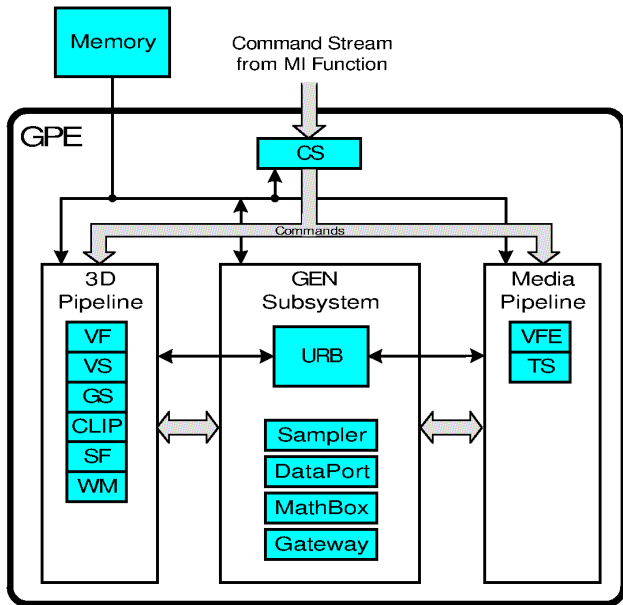

Ring commands processing

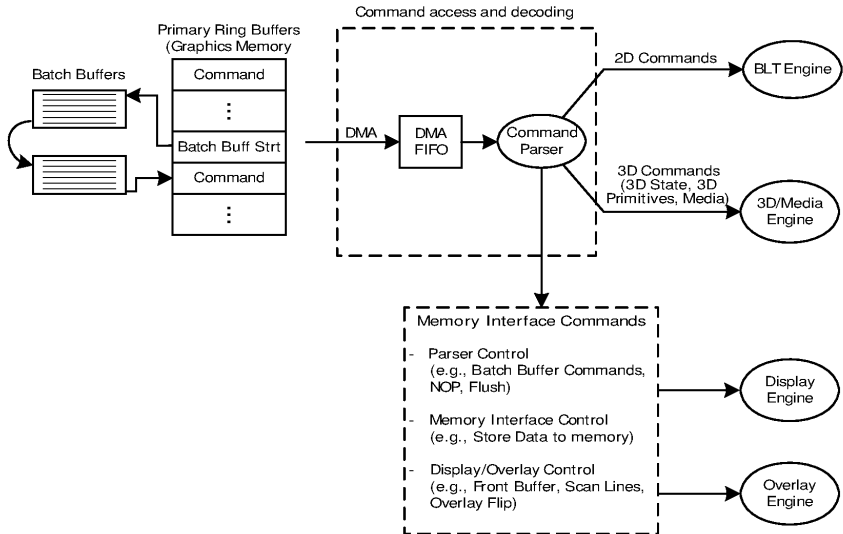

GPU memory address translation path

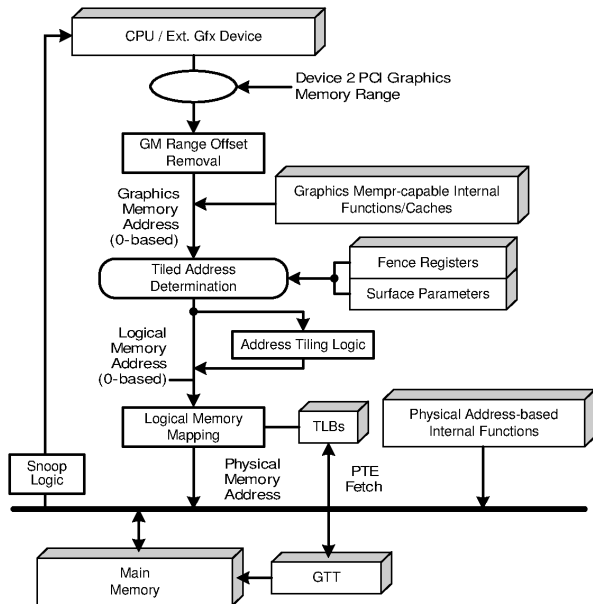

GTT paging

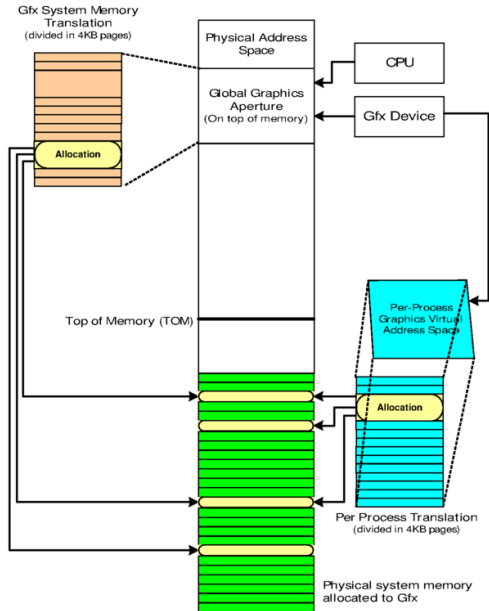

Video output

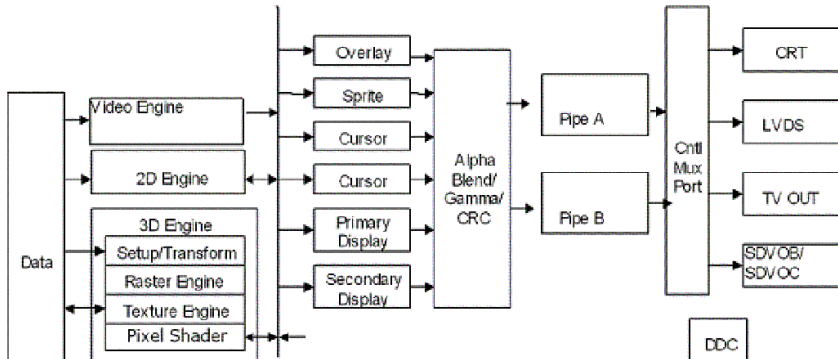

Graphics stack

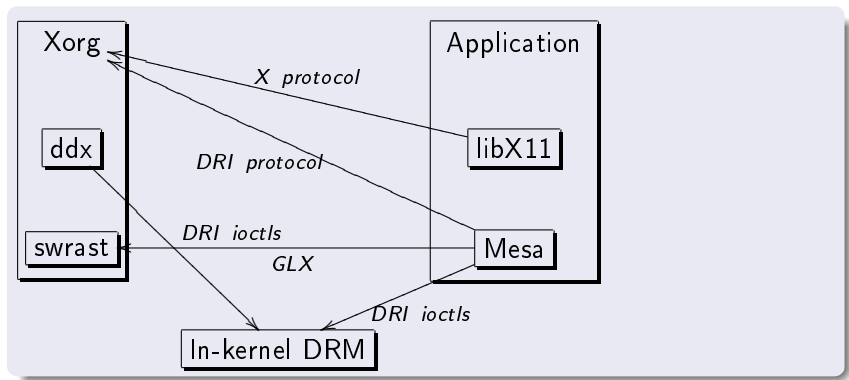

GEM - Graphics Execution Manager

- Memory allocation and translation management
 - Aperture and GTT - AGP driver
- Tiling and swizzling
- Buffer object content and caching management
- Ring execution control

KMS - Kernel Mode Setting

- Output enumeration
- Monitor parameters, EDID
- Mode setting
- vblank handling
- Page flips

Инфраструктура

- Multi-master
- DRM Platforms (USB video)

Radeon driver

- TTM port
- KMS

Maintainers

- Импорт изменений из линукса
- Исправления