

# Feature-rich and fast SCSI target with CTL and ZFS

Alexander Motin <[mav@FreeBSD.org](mailto:mav@FreeBSD.org)>  
iXsystems, Inc.

RuBSD'2014

# CTL – CAM Target Layer

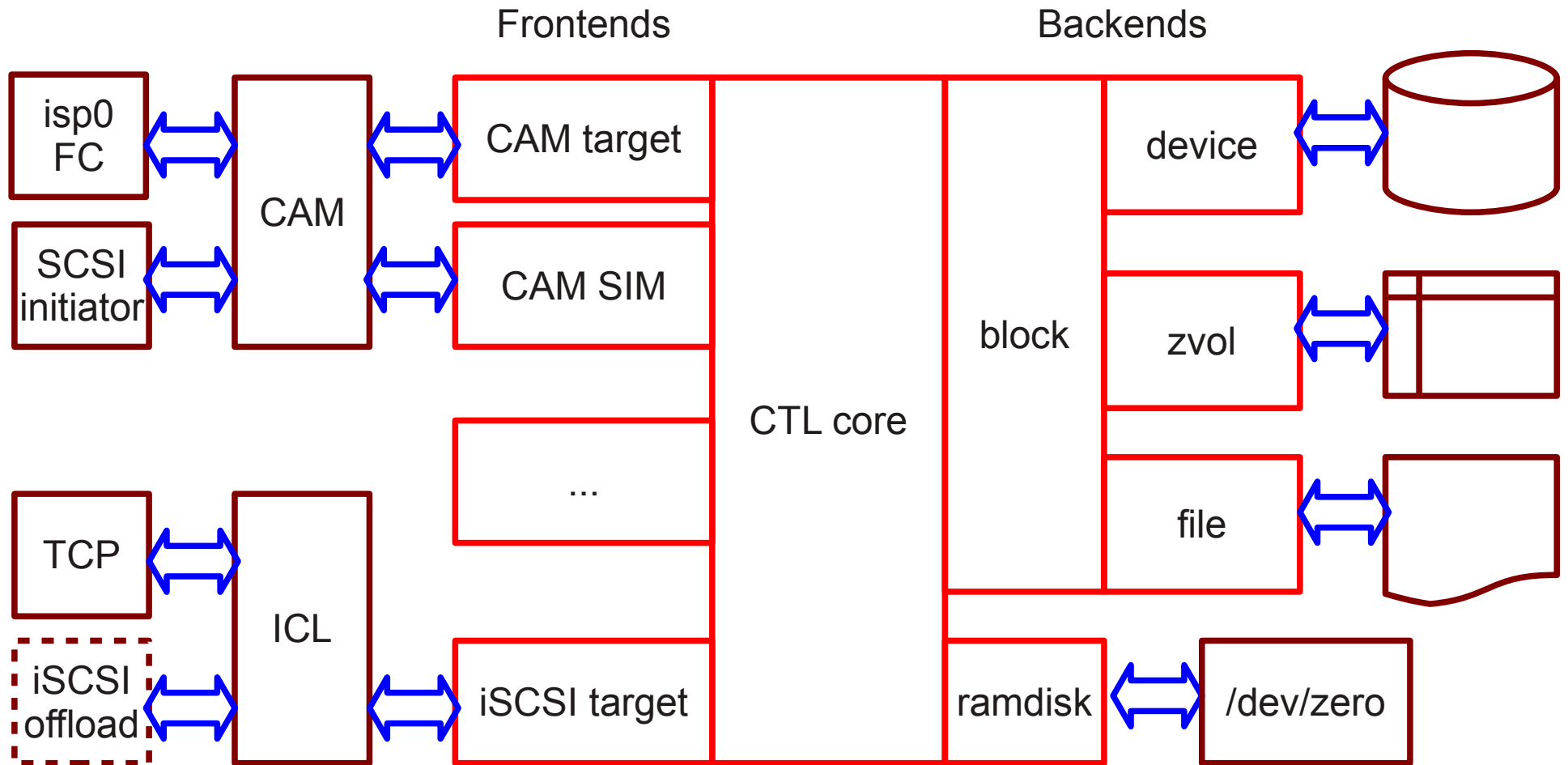

# CTL functional improvements

... for intelligent performance

- I/O optimization for storage specifics
- Thin-/Resource-provisioning
- I/O offload

# CTL functional improvements

Basic SCSI disk (CTL in early 2014):

- READ CAPACITY(10)
  - Get block size and number of blocks

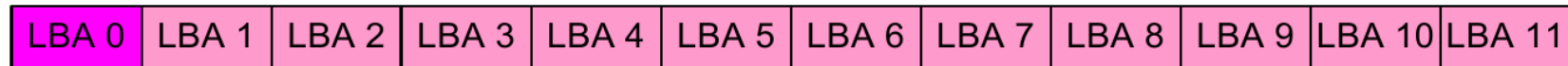

- READ
  - Read range of blocks
- WRITE
  - Write range of blocks

```
# diskinfo -v /dev/da0  
/dev/da0
```

```
512 # sectorsize  
107374182400 # mediasize in bytes (100G)  
209715200 # mediasize in sectors
```

# CTL functional improvements

## Advanced Format (512e) SCSI disks:

- READ CAPACITY(16)
  - Get physical block size and offset

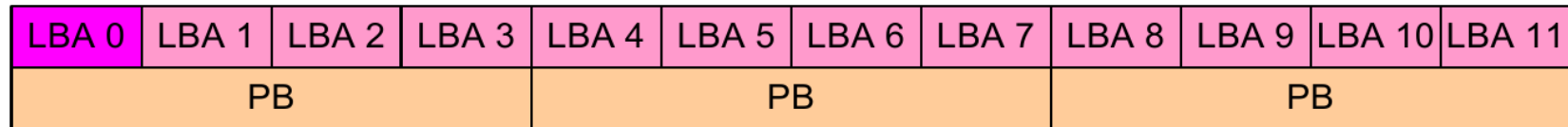

```
# diskinfo -v /dev/da0  
/dev/da0
```

```
512          # sectorsize  
107374182400 # mediasize in bytes (100G)  
209715200    # mediasize in sectors  
8192        # stripesize  
0           # stripeoffset
```

# CTL functional improvements

## Basic thin-provisioned disks:

- Logical Block Provisioning VPD **VAAI TP Reporting**
  - Get Supported UNMAP commands
- Block Limits VPD page
  - Get UNMAP block size

| LBA 0 | LBA 1 | LBA 2    | LBA 3 | LBA 4 | LBA 5 | LBA 6    | LBA 7 |
|-------|-------|----------|-------|-------|-------|----------|-------|
| PB    |       | Unmapped |       | PB    |       | Unmapped |       |

- Get UNMAP parameters limitations
- WRITE SAME with UNMAP
  - Unmap sequential range of blocks
- UNMAP
  - Unmap arbitrary list of blocks
- Proper overflow error reporting

**VAAI Unmap**



**VAAI TP Stun**

# CTL functional improvements

Featured thin-provisioned disk:

- GET LBA STATUS
  - Get provisioning status of specific block(s)

Windows defrag

| Drive   | Media type             | Last run         | Current status             |
|---|------------------------|------------------|----------------------------|
|  (C:)            | Solid state drive      | Never run        | Needs optimization         |
|  iSCSI disk (E:) | Thin provisioned drive | 10.12.2014 22:28 | OK (100% space efficiency) |
|  System Reserved | Solid state drive      | Never run        | Needs optimization         |

# CTL functional improvements

## Featured thin-provisioned disk:

- Logical Block Provisioning log page
  - Get space usage statistics

```
# sg_logs -p 0x0c da20
```

```
    FREEBSD    CTLDISK          0001
```

```
Logical block provisioning page [0xc]
```

```
  Available LBA mapping threshold resource count: 2554830
```

```
  Scope: not dedicated to lu
```

```
  Used LBA mapping threshold resource count: 91
```

```
  Scope: dedicated to lu
```



# CTL functional improvements

Featured thin-provisioned disk:

- Logical Block Provisioning mode page
  - Get/set space usage threshold notifications

## VAAI Thin Provisioning Space Threshold Warning

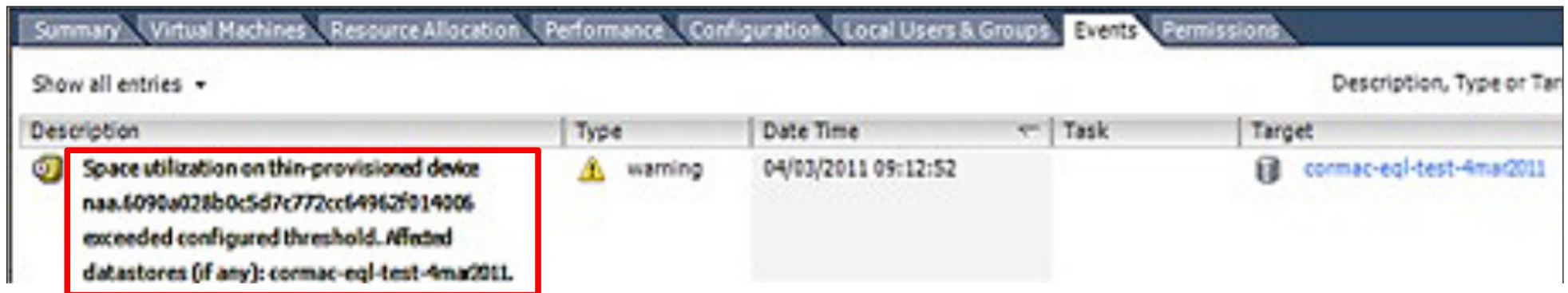

The screenshot shows the VMware vSphere Event Viewer interface. The 'Events' tab is selected, and a single warning event is displayed. The event description, which is highlighted with a red box, reads: 'Space utilization on thin-provisioned device naa.6090a028b0c5d7c772cc64962f014006 exceeded configured threshold. Affected datastores (if any): cormac-eql-test-4ma2011.' The event type is 'warning' and it occurred on 04/03/2011 at 09:12:52. The target of the event is 'cormac-eql-test-4ma2011'.

| Description   | Type    | Date Time           | Task | Target                  |
|---|---------|---------------------|------|-------------------------|
| Space utilization on thin-provisioned device naa.6090a028b0c5d7c772cc64962f014006 exceeded configured threshold. Affected datastores (if any): cormac-eql-test-4ma2011. | warning | 04/03/2011 09:12:52 |      | cormac-eql-test-4ma2011 |

# CTL functional improvements

## Basic offloaded disk:

- COMPARE AND WRITE

VAAI ATS

- Atomic operations to avoid LUN reservations

- VERIFY

Windows chkdsk

- Verify data without transfer

```
Stage 5: Looking for bad, free clusters ...  
Progress: 2702142 of 26153765 done; Stage: 10%; Total: 10%; ETA: 0:03:15
```

iSCSI disk (E:)

100GB in 3:34 = 467MB/s verify with 500KB/s traffic

- WRITE SAME

VAAI Zero

- Write disk with pattern or zeroes

# vSphere 5.5 Eager Zero creating 40GB VM

## Recent Tasks

| Name                     | Target               | Status    | Details | Start Time          | Completed Time      |
|--------------------------|----------------------|-----------|---------|---------------------|---------------------|
| Relocate virtual machine | 40GB Virtual Machine | Completed |         | 08.12.2014 23:22:18 | 08.12.2014 23:22:48 |
| Create virtual machine   | mavhome              | Completed |         | 08.12.2014 23:21:14 | 08.12.2014 23:21:24 |
| Rescan VMFS              | 192.168.4.101        | Completed |         | 08.12.2014 23:19:29 | 08.12.2014 23:19:29 |
| Rescan all HBAs          | 192.168.4.101        | Completed |         | 08.12.2014 23:19:23 | 08.12.2014 23:19:29 |

40GB in 10 seconds – 4GB/s disk write

| packets | errs | idrops | bytes   | packets | errs | bytes   | colls |
|---------|------|--------|---------|---------|------|---------|-------|
| 2       | 0    | 0      | 180     | 3       | 0    | 362     | 0     |
| 3480    | 0    | 0      | 1740864 | 2475    | 0    | 7050330 | 0     |
| 11317   | 0    | 0      | 7552298 | 11087   | 0    | 1135586 | 0     |
| 9083    | 0    | 0      | 6164486 | 9068    | 0    | 935036  | 0     |
| 7201    | 0    | 0      | 4619810 | 6947    | 0    | 706314  | 0     |
| 8516    | 0    | 0      | 5724648 | 8413    | 0    | 869216  | 0     |
| 7525    | 0    | 0      | 4979642 | 7435    | 0    | 757080  | 0     |
| 6648    | 0    | 0      | 4210176 | 6440    | 0    | 648980  | 0     |
| 7046    | 0    | 0      | 4452684 | 6831    | 0    | 673058  | 0     |
| 8027    | 0    | 0      | 5081110 | 7793    | 0    | 770006  | 0     |
| 2674    | 0    | 0      | 1499828 | 2339    | 0    | 1503434 | 0     |
| 1       | 0    | 0      | 66      | 1       | 0    | 294     | 0     |

4-7MB/s network traffic

# CTL functional improvements

Featured offloaded disk v1 (XCOPY ala SPC-3):

- RECEIVE COPY OPERATING PARAMETERS
  - Get supported parameters
- XCOPY
  - Copy data from source to destination
- RECEIVE COPY STATUS
  - Check status of copy operation

VAAI Extended Copy

# vSphere 5.5 migrating 40GB VM

## Recent Tasks

| Name                     | Target               | Status    | Details | Start Time          | Completed Time      |
|--------------------------|----------------------|-----------|---------|---------------------|---------------------|
| Relocate virtual machine | 40GB Virtual Machine | Completed |         | 08.12.2014 23:22:18 | 08.12.2014 23:22:48 |
| Create virtual machine   | mavhome              | Completed |         | 08.12.2014 23:21:14 | 08.12.2014 23:21:24 |
| Rescan VMFS              | 192.168.4.101        | Completed |         | 08.12.2014 23:19:29 | 08.12.2014 23:19:29 |
| Rescan all HBAs          | 192.168.4.101        | Completed |         | 08.12.2014 23:19:23 | 08.12.2014 23:19:29 |

40GB in 30 seconds – 1.3GB/s copy

| packets | errs | idrops | bytes  | packets | errs | bytes  | colls |
|---------|------|--------|--------|---------|------|--------|-------|
| 1077    | 0    | 0      | 755914 | 881     | 0    | 102582 | 0     |
| 940     | 0    | 0      | 702936 | 784     | 0    | 86260  | 0     |
| 972     | 0    | 0      | 719384 | 793     | 0    | 95526  | 0     |
| 978     | 0    | 0      | 735044 | 816     | 0    | 89620  | 0     |
| 942     | 0    | 0      | 731644 | 796     | 0    | 96156  | 0     |
| 983     | 0    | 0      | 720014 | 805     | 0    | 88126  | 0     |
| 1003    | 0    | 0      | 722550 | 821     | 0    | 97134  | 0     |
| 997     | 0    | 0      | 706698 | 820     | 0    | 88444  | 0     |
| 939     | 0    | 0      | 702870 | 786     | 0    | 86200  | 0     |
| 965     | 0    | 0      | 705802 | 792     | 0    | 94980  | 0     |
| 959     | 0    | 0      | 689950 | 775     | 0    | 84898  | 0     |
| 837     | 0    | 0      | 624938 | 682     | 0    | 76456  | 0     |

700KB/s network traffic

# CTL functional improvements

Featured offloaded disk v2 (XCOPY SPC-4/Lite):

- Third Party Copy VPD page
  - Get supported parameters
- POPULATE TOKEN
  - Read data from source to token
- RECEIVE ROD TOKEN INFORMATION
  - Get token
- WRITE USING TOKEN
  - Write data from token to destination

Microsoft ODX

# Windows 2012R2 copying 10GB file

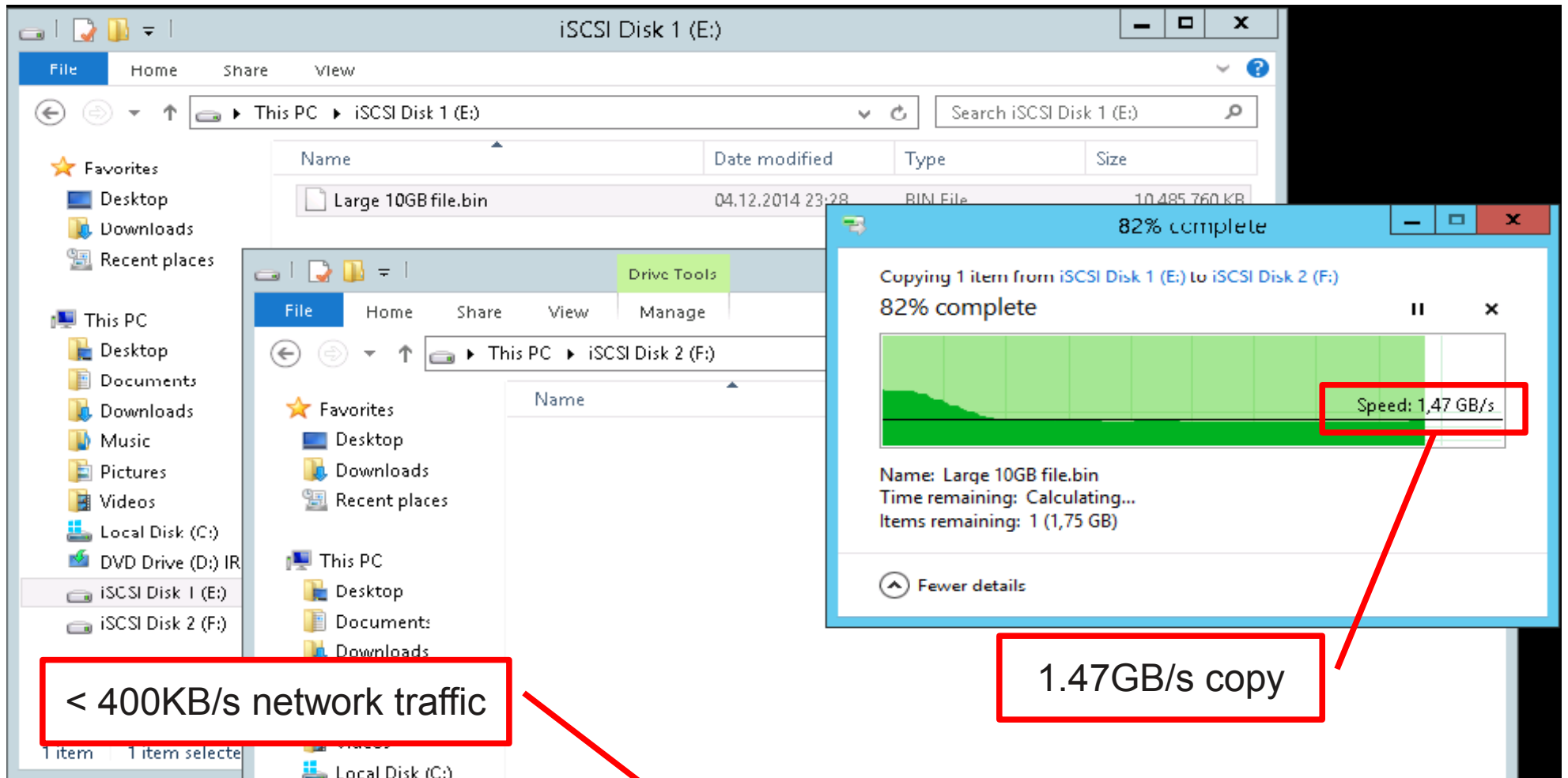

1.47GB/s copy

| packets | errs | idrops | bytes  | packets | errs | bytes | colls |
|---------|------|--------|--------|---------|------|-------|-------|
| 26      | 0    | 0      | 16416  | 26      | 0    | 2732  | 0     |
| 270     | 0    | 0      | 381074 | 152     | 0    | 9764  | 0     |
| 28      | 0    | 0      | 17724  | 28      | 0    | 2936  | 0     |
| 27      | 0    | 0      | 17070  | 27      | 0    | 2834  | 0     |

# CTL functional improvements

... for intelligent performance

CTL got support:

- VMware VAAI Block
- VMware VAAI Thin Provisioning
- Microsoft Offloaded Data Transfer (ODX)

... and more.



# CTL functional improvements

## Support for ...

Test Unit Ready  
Request Sense  
Format Unit  
Read(6)  
Write(6)  
Inquiry  
Mode select(6)  
Reserve(6)  
Release(6)  
Mode sense(6)  
Start stop unit  
Read capacity(10)  
Read(10)  
Write(10)  
Write and verify(10)  
Verify(10)  
Synchronize cache(10)  
Read defect data(10)  
Write buffer  
Read buffer  
Write same(10)  
Unmap  
Log sense  
Mode select(10)  
Reserve(10)

Release(10)  
Mode sense(10)  
Persistent reserve in, read keys  
Persistent reserve in, read reservation  
Persistent reserve in, report capabilities  
Persistent reserve in, read full status  
Persistent reserve out, register  
Persistent reserve out, reserve  
Persistent reserve out, release  
Persistent reserve out, clear  
Persistent reserve out, preempt  
Persistent reserve out, preempt and abort  
Persistent reserve out, register and ignore existing key  
Extended copy(LID1)  
Extended copy(LID4)  
Populate token  
Write using token  
Copy operation abort  
Receive copy status(LID1)  
Receive copy operating parameters  
Receive copy failure details(LID1)

Receive copy status(LID4)  
Receive ROD token information  
Report all ROD tokens  
Read(16)  
Compare and write  
Write(16)  
Write and verify(16)  
Verify(16)  
Synchronize cache(16)  
Write same(16)  
Write atomic(16)  
Read capacity(16)  
Get LBA status  
Report luns  
Report target port groups  
Report supported operation codes  
Report supported task management functions  
Report timestamp  
Read(12)  
Write(12)  
Write and verify(12)  
Verify(12)  
Read defect data(12)

... 69 commands

# CTL performance improvements

... for brute force performance

CTL got long list of optimizations:

- Multiple threads instead of single;
- Per-LUN and per-queue locks instead of single;
- Status and data transfer coalescing;
- UMA zones instead of own allocator;
- Reduced per-LUN memory use;
- Many optimizations to iSCSI and isp(4) code.

# Peak iSCSI IOPS/Throughput

## Test setup:

### •Target:

- 2xXeon E5-2690v2 @ 3.00GHz (40 SMT cores)
- 256GB RAM
- 1xChelsio T580-LP-CR 40Gbps NIC
- 1xChelsio T520-CR 2x10Gbps NIC
- 20xIntel 520/530 Series SSD
- 6x100GB ZVOL-backed iSCSI LUNs

### •Initiators:

- 3xCore i7 desktop machines with 10/40Gbps NICs
- 2xiSCSI connections per NIC.

Test: Multi-threaded linear read from all 6 LUNs through each iSCSI connection with different block sizes.

# Peak iSCSI IOPS/Throughput

## Test 1: Full acceleration (TOE + Jumbo Frames)

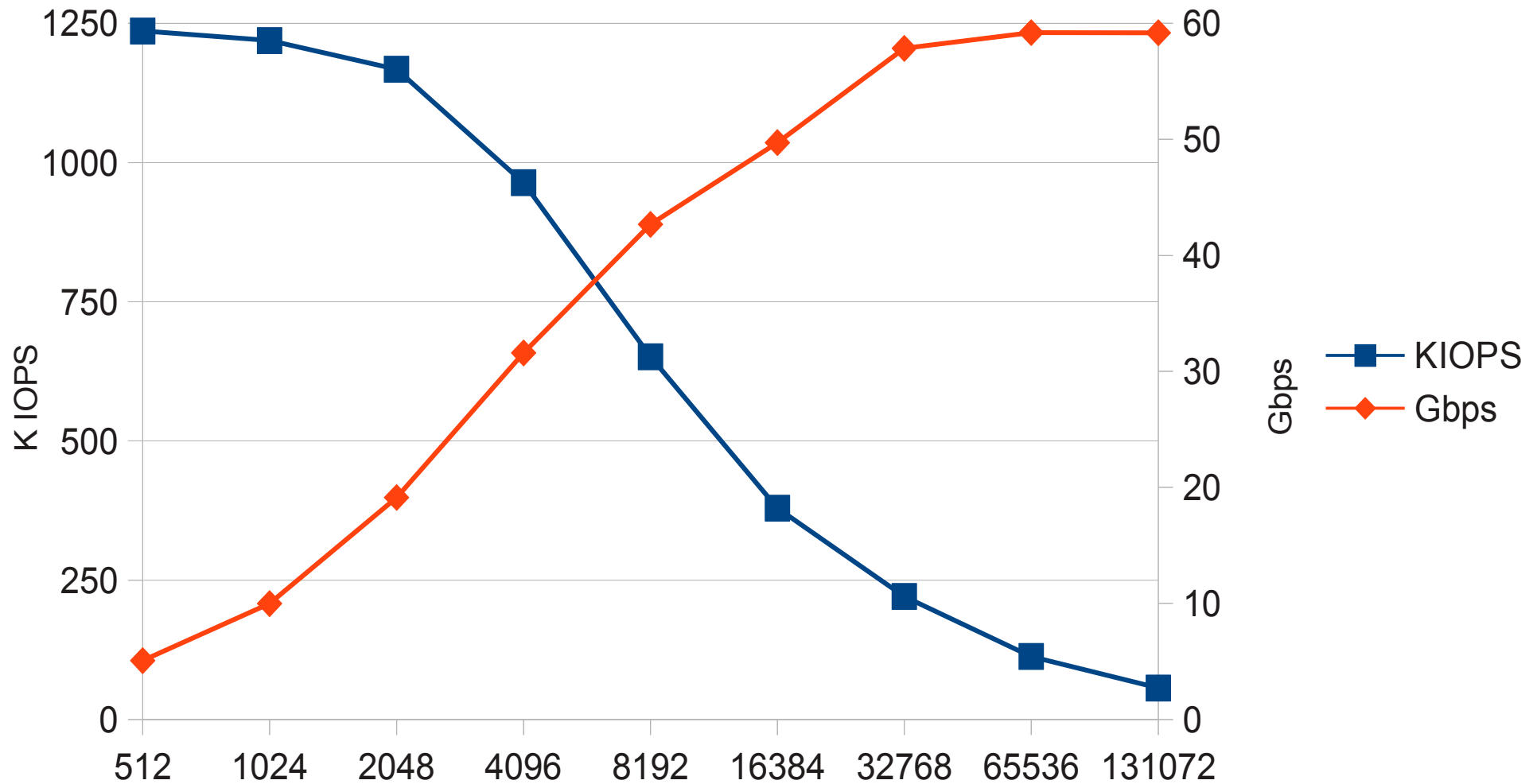

# Peak iSCSI IOPS/Throughput

## Test 2: T1 - TOE (TSO + LRO + Jumbo Frames)

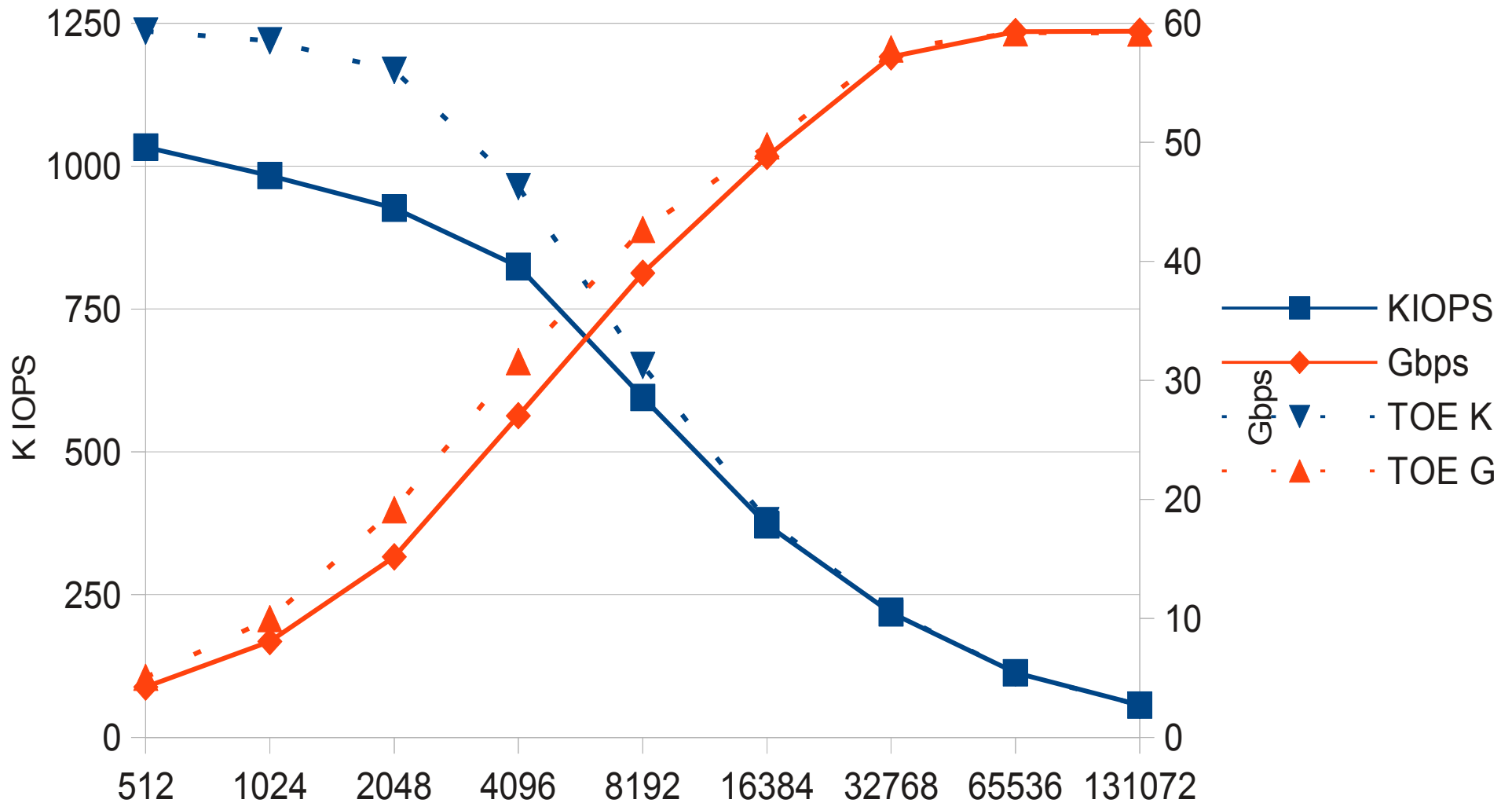

# Peak iSCSI IOPS/Throughput

## Test 3: T2 - Jumbo (TSO + LRO)

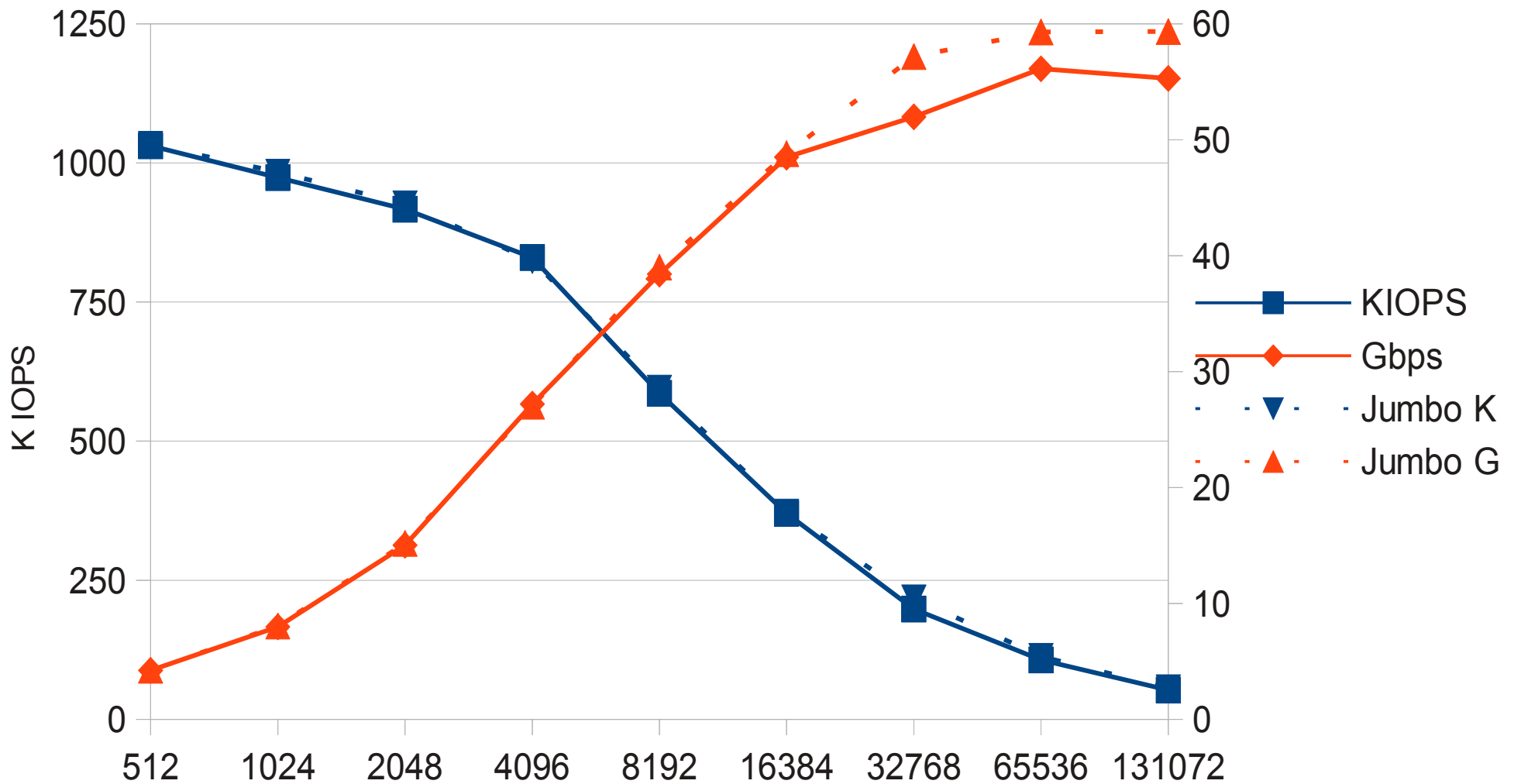

# Peak iSCSI IOPS/Throughput

## Test 4: T2 - TSO - LRO (Jumbo Frames)

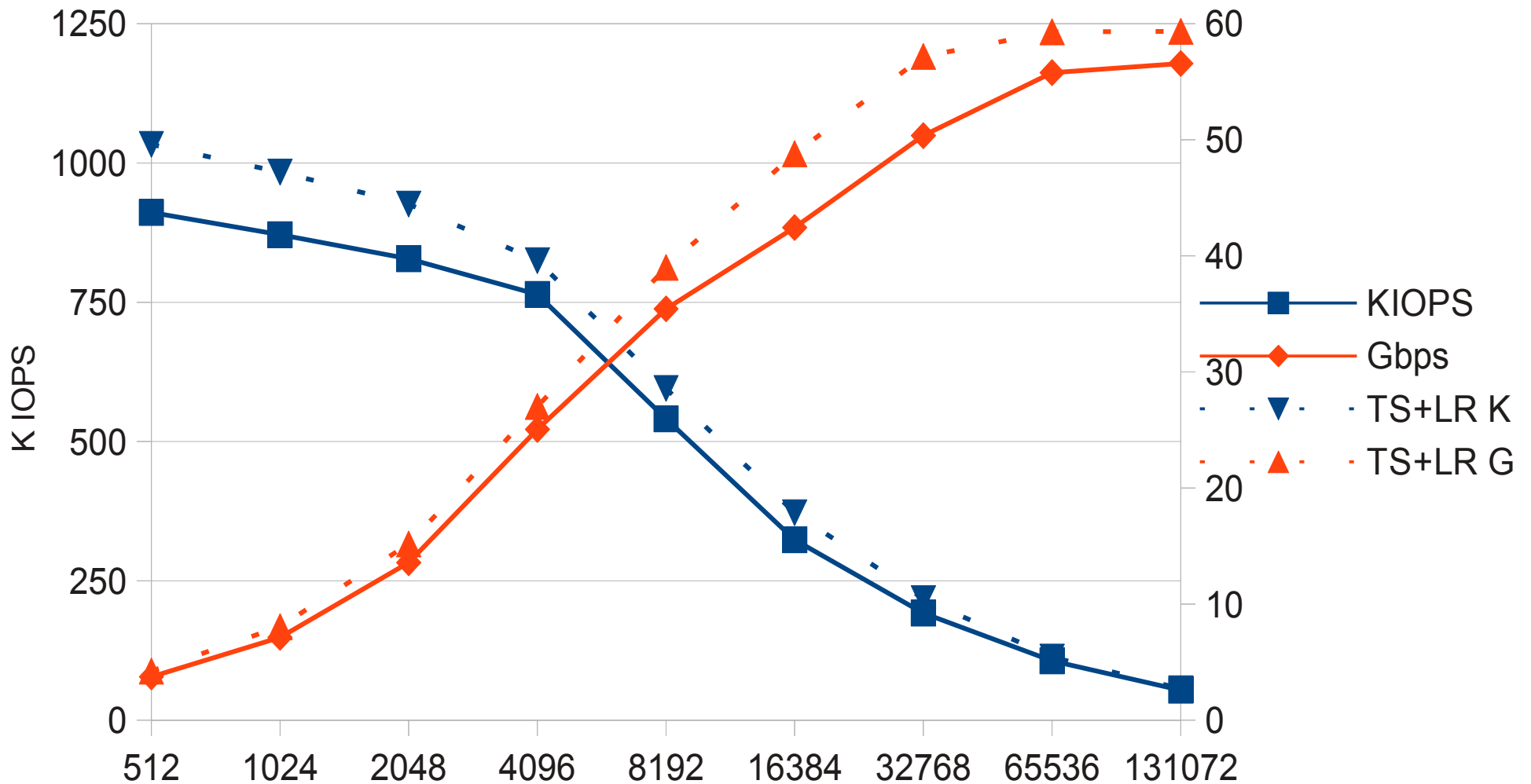

# Peak iSCSI IOPS/Throughput

## Test 5: T3 - TSO - LRO (No acceleration)

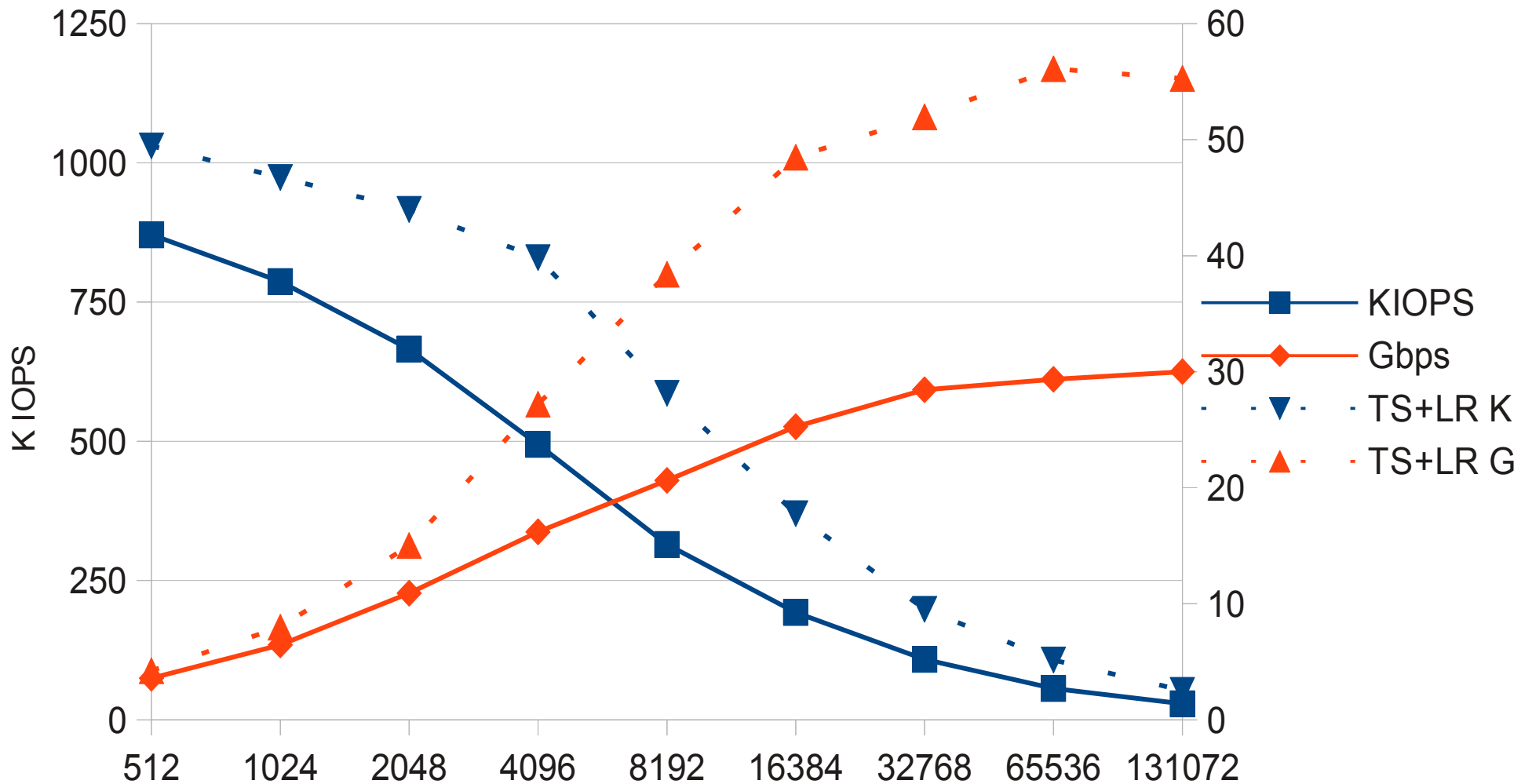



# Peak iSCSI IOPS/Throughput Summary graph

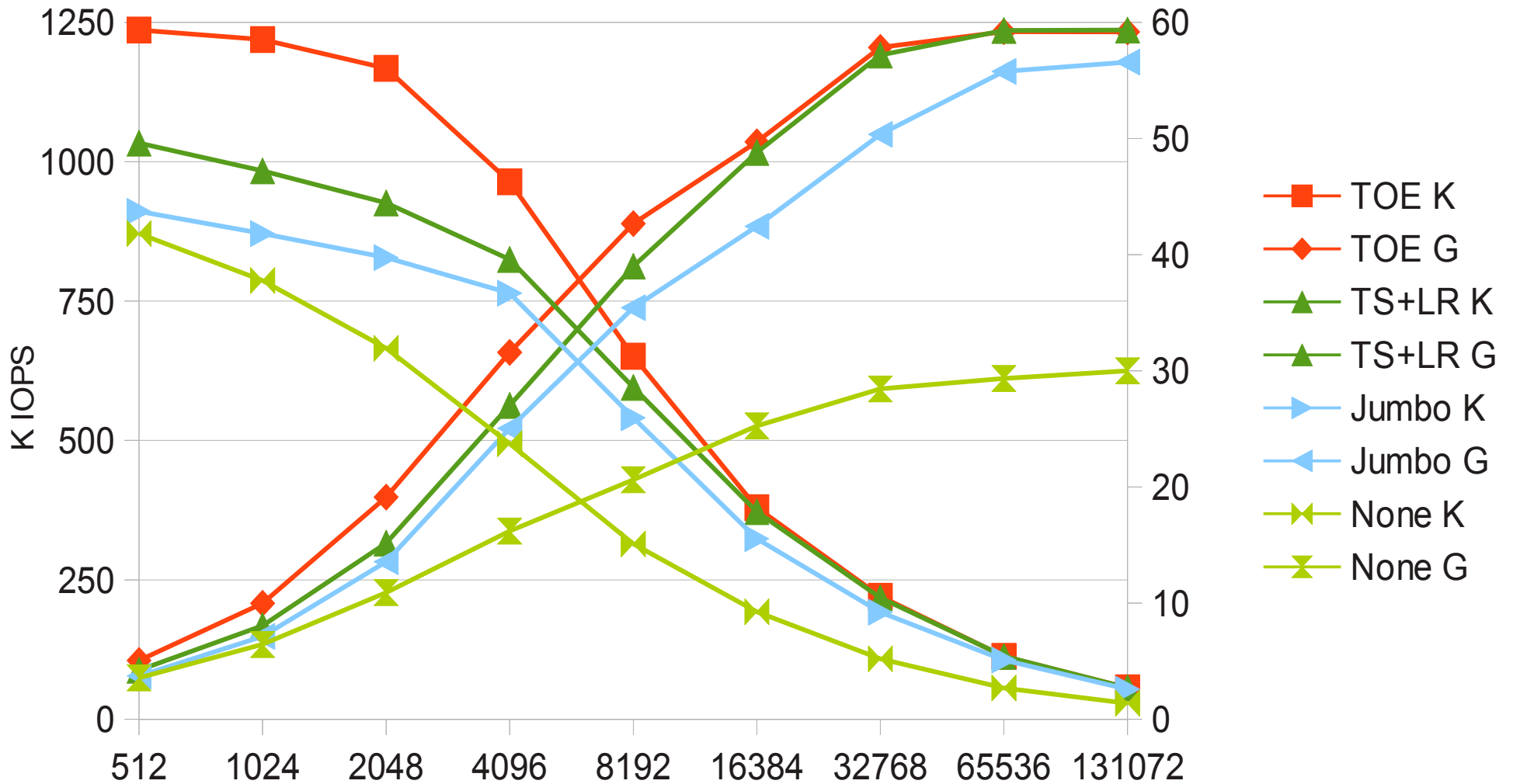

# Peak Fibre Channel IOPS/Throughput

Test setup:

- Target:

- 2xXeon E5-2690v2 @ 3.00GHz (40 SMT cores)
- 256GB RAM
- 1xQlogic QLE2562 2x8Gbps FC HBA
- 20xIntel 520/530 Series SSD
- 6x100GB ZVOL-backed iSCSI LUNs

- Initiator:

- Core i7 desktop machine
- 1xQlogic QLE2562 2x8Gbps FC HBA

Test: Multi-threaded linear read from all 6 LUNs through each FC port with different block sizes.

# Peak Fibre Channel IOPS/Throughput

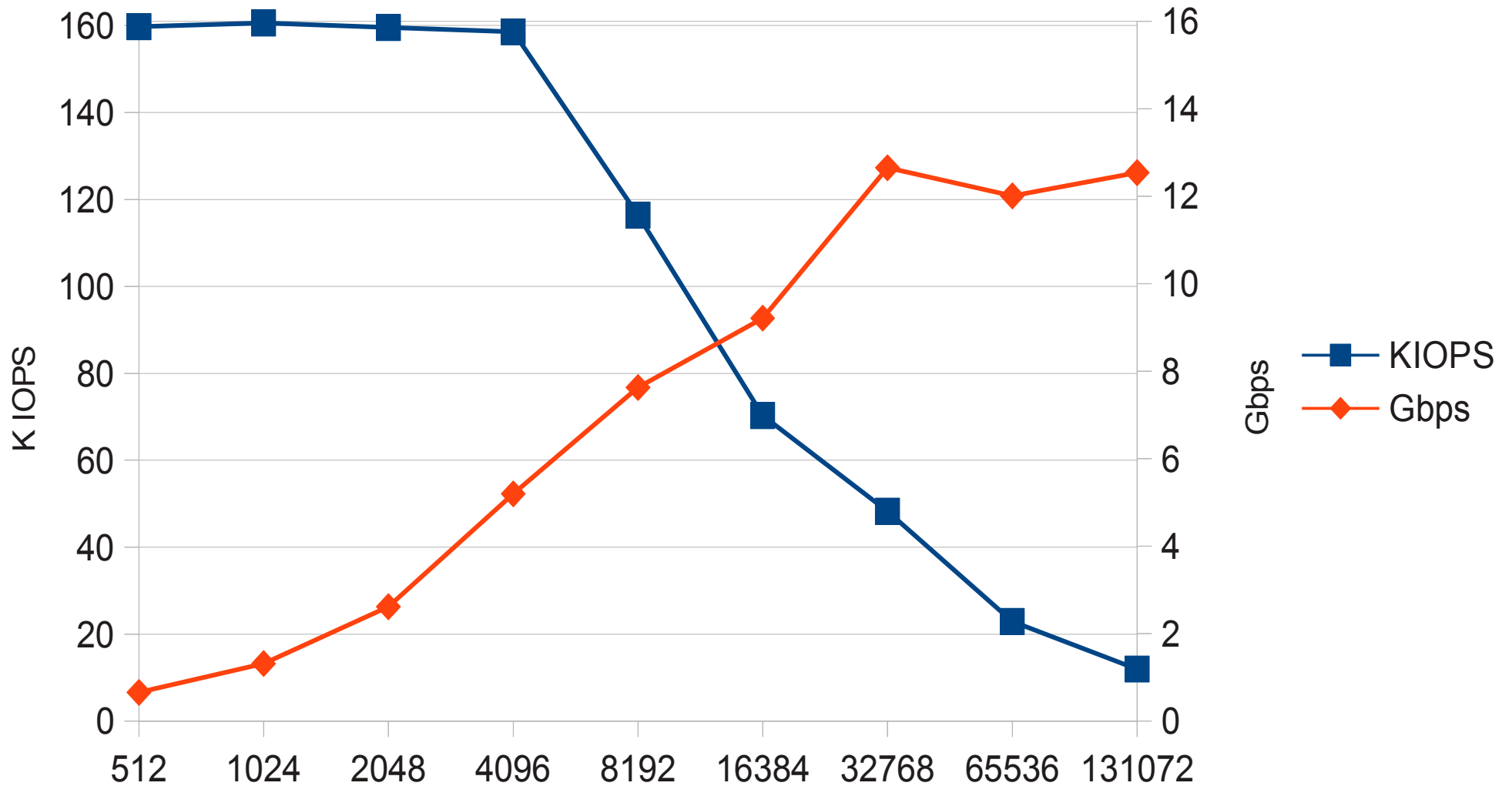

# Further improvements

## Plans and/or wishes:

- Implement XCOPY without copy (manual dedup)
- Implement XCOPY between hosts
- Recreate HA/clustering support
- Improve ZFS prefetch
- Improve Fibre Channel support



freeBSD®



FreeNAS®

**Thank you!**

